

TIENDA GAIA

INDICE

- 1 PLANTA ARQUITECTÓNICA
- 2 VISUALIZACION 3D
- 3 DETALLES
- 4 COMPRAS

NOTA: LAS MEDIDAS DE PLANOS SON APROXIMADAS.

Es imprescindible replantear las medidas antes de ejecutar en el espacio.

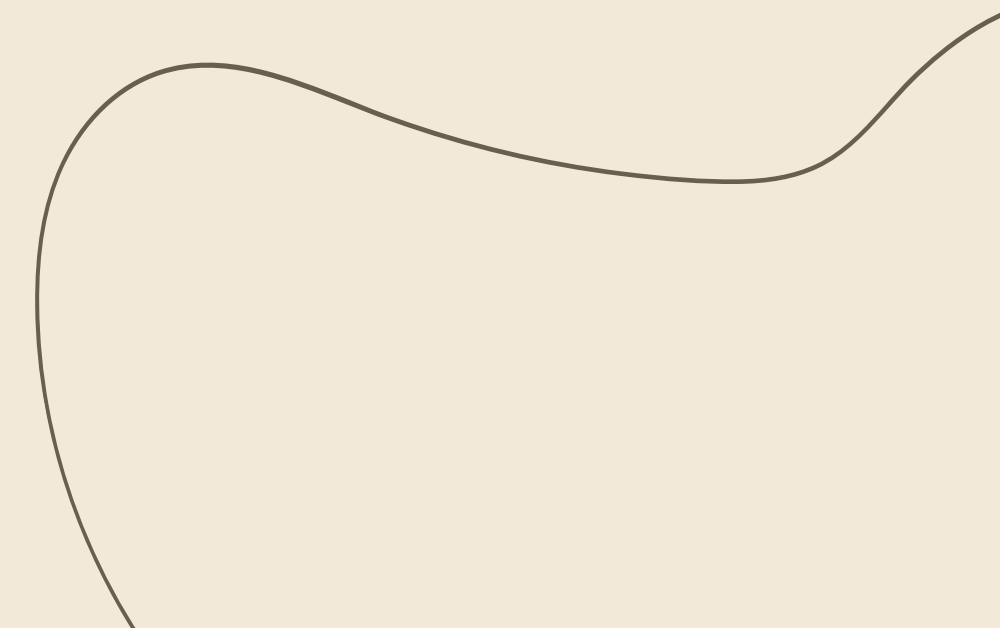



TIENDA



- 1. ESTANTE DE CARTERA Y CALZADOS
- 2. SILLON
- 3. VITRINA
- 4. ESTANTE DE CALZADOS ESCALONADOS
- 5. PLANTA DECORATIVA
- 6. COUNTER EN L
- 7. LETRERO, ESPEJO Y AREA DE SOMBREROS
- 8. MUEBLE PARA ALMACENAMIENTO
- 9. CLOSET DE ROPA

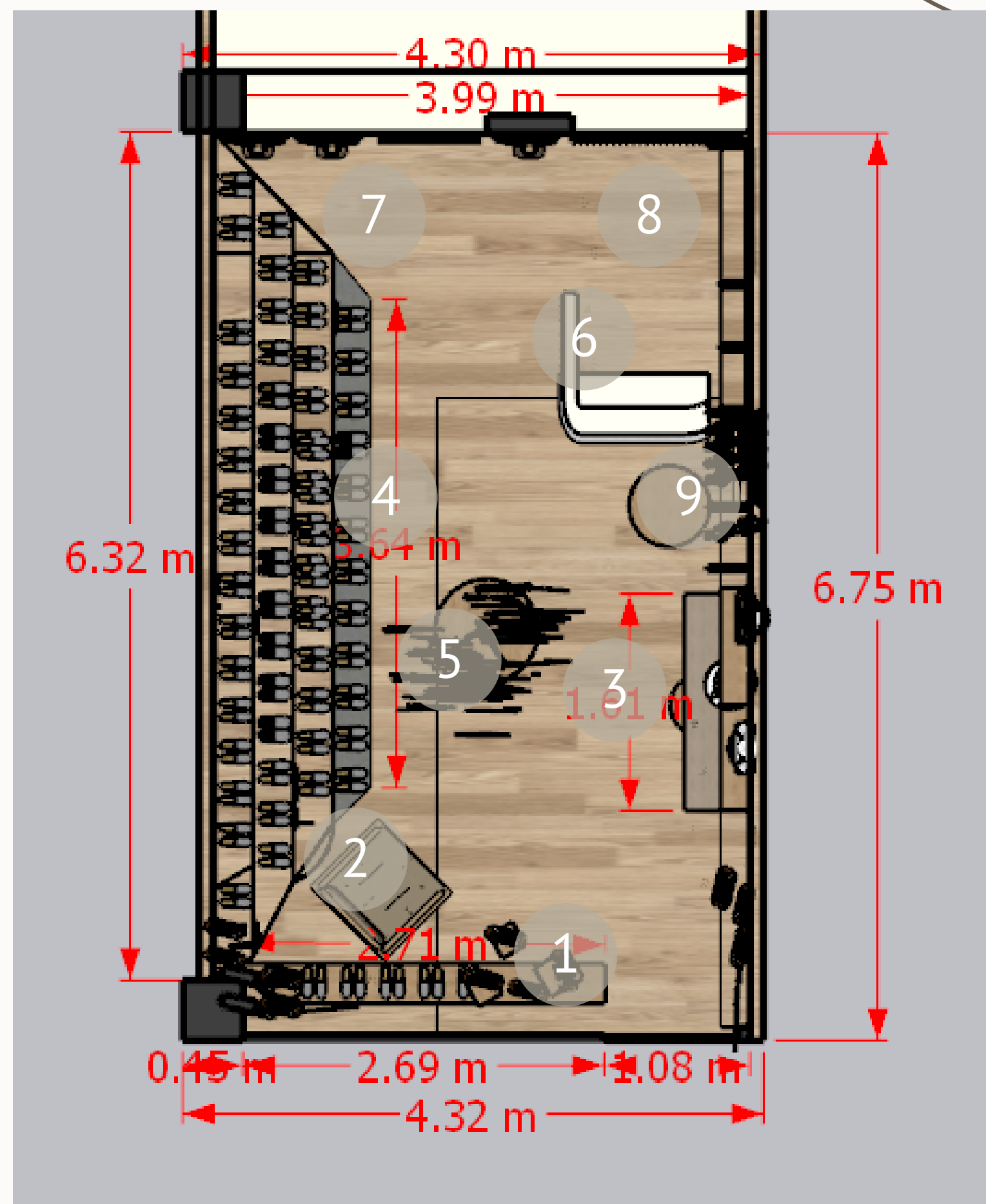

1

PLANTA ARQUITECTÓNICA / DIMENSIONADA



2

VISUALIZACION 3D



2

VISUALIZACION 3D



2

VISUALIZACION 3D



2

VISUALIZACION 3D



2

VISUALIZACION 3D

1. ESPEJO RETROILUMINADO
2. ESTANTE PARA CALZADOS
3. PARED DE SOMBREROS
4. PALILLERIA
5. ESTANTE CON PAJILLA
6. COUNTER EN L CON EXHIBIDOR
7. VITRINA
8. PLANTA DECORATIVA
9. OTOMANES EN MADERA
10. CLOSET EXHIBIDOR DE ROPA
11. PERFILES DE LUCES
12. RIELES DE LUZ

NOTA: LOS TONOS DEBEN SER ELEGIDOS ENTRE EL ENCARGADO DE EJECUCION DE OBRA Y EL CLIENTE, CON PALETA SHERWIN WILLIAMS



3

DETALLES

1. CIRCULOS EXHIBIDORES
2. ESPEJO RETROILUMINADO
3. COUNTER EN L CON EXHIBIDOR
4. ESTANTE DE CALZADO ESCALONADO
5. ESTANTE DE CALZADOS Y CARTERAS
6. PLANTA DECORATIVA
7. SOMBREROS

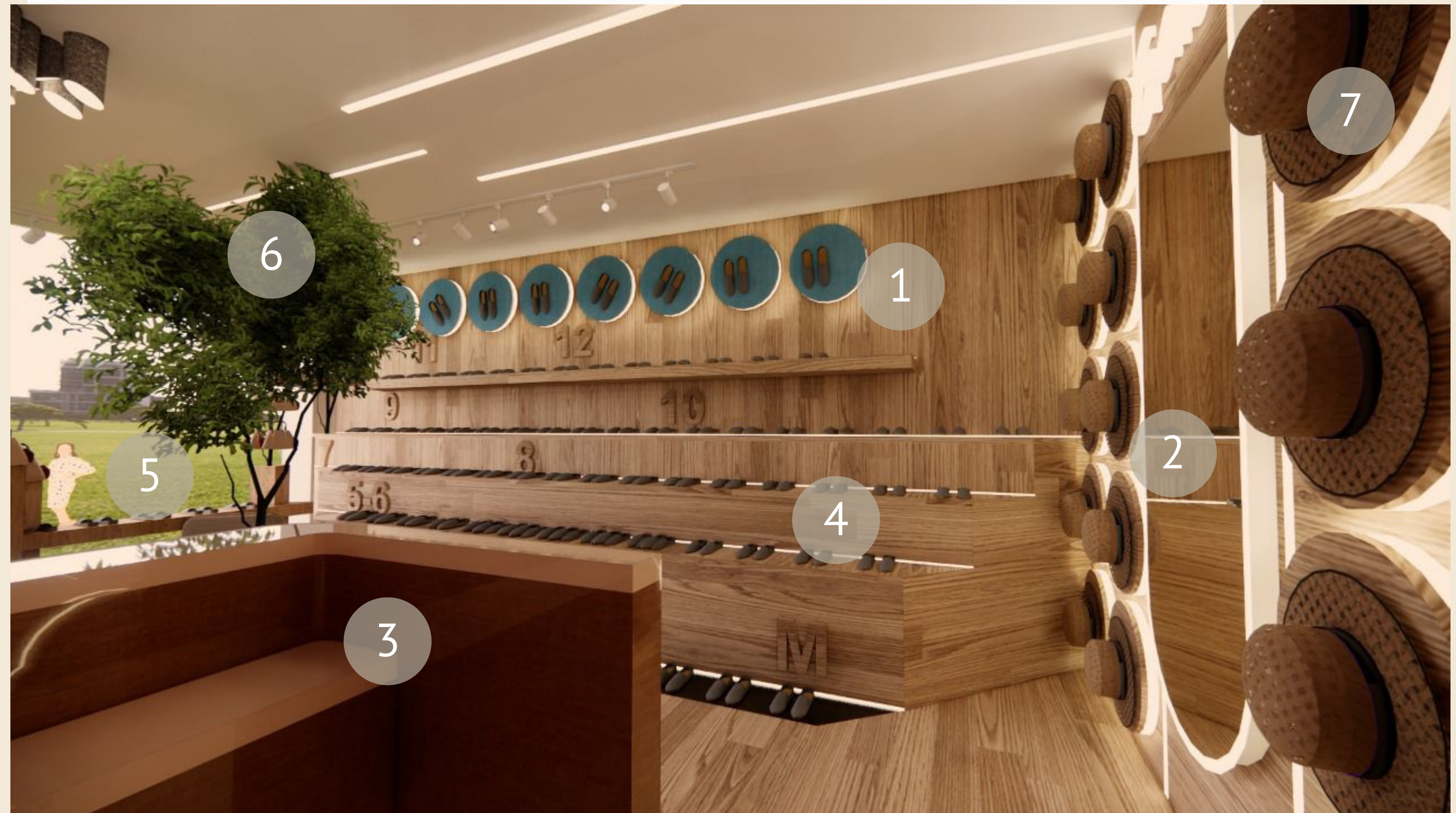

3

DETALLES

- 1. VITRINA
- 2. SOGAS TENSADAS
- 3. MICROCEMENTO
- 4. LAMPARA
- 5. OTOMANES EN MADERA
- 6. REPISAS FLOTANTES



3

DETALLES

- 1. SOMBREROS
- 2. ESPEJO I L U M I N A D O
- 3. LETRERO I L U M I N A D O
- 4. PALILLERIA
- 5. PAPEL TAPIZ

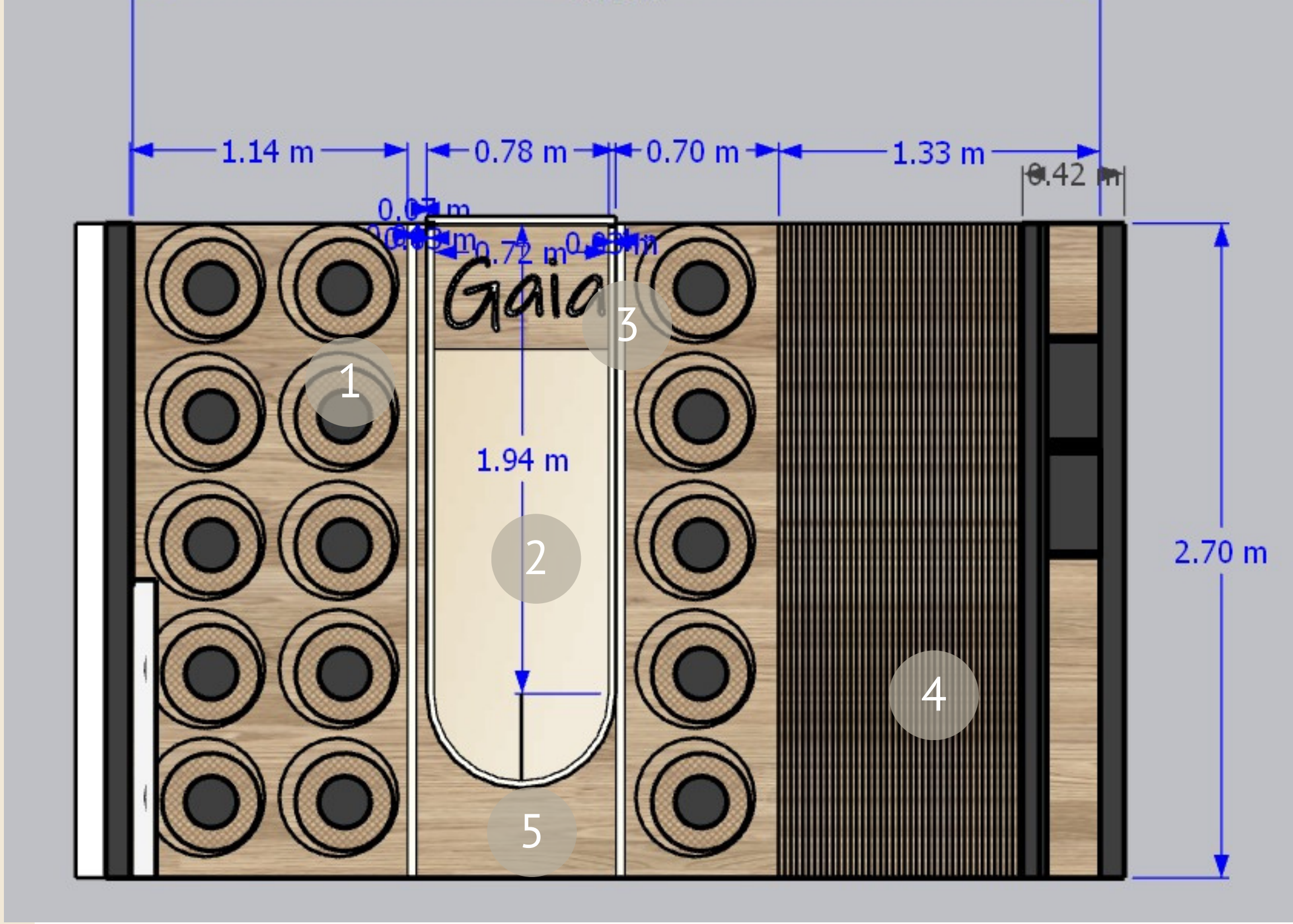

3

DETALLES

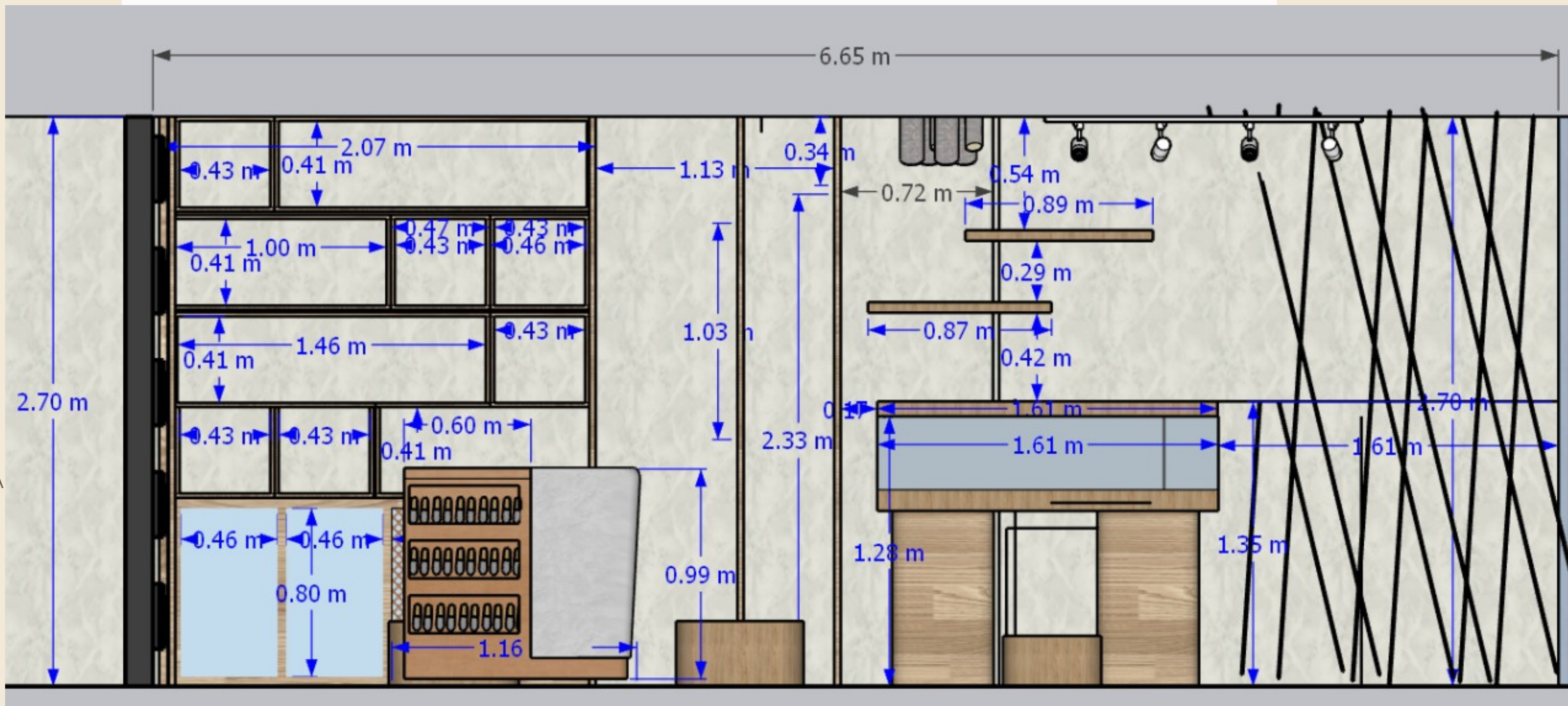

- 1. VITRINA
- 2. HILOS TENSADOS
- 3. MICROCEMENTO
- 4. LAMPARA
- 5. OTOMANES EN MADERA
- 6. REPISAS FLOTANTES

3

DETALLES

- 1. PUERTA DE ENTRADA
- 2. ESTANTE EN MADERA DE CALZADOS Y CARTERAS
- 3. HILOS TENSADOS EXHIBIDOR DE CARTERAS

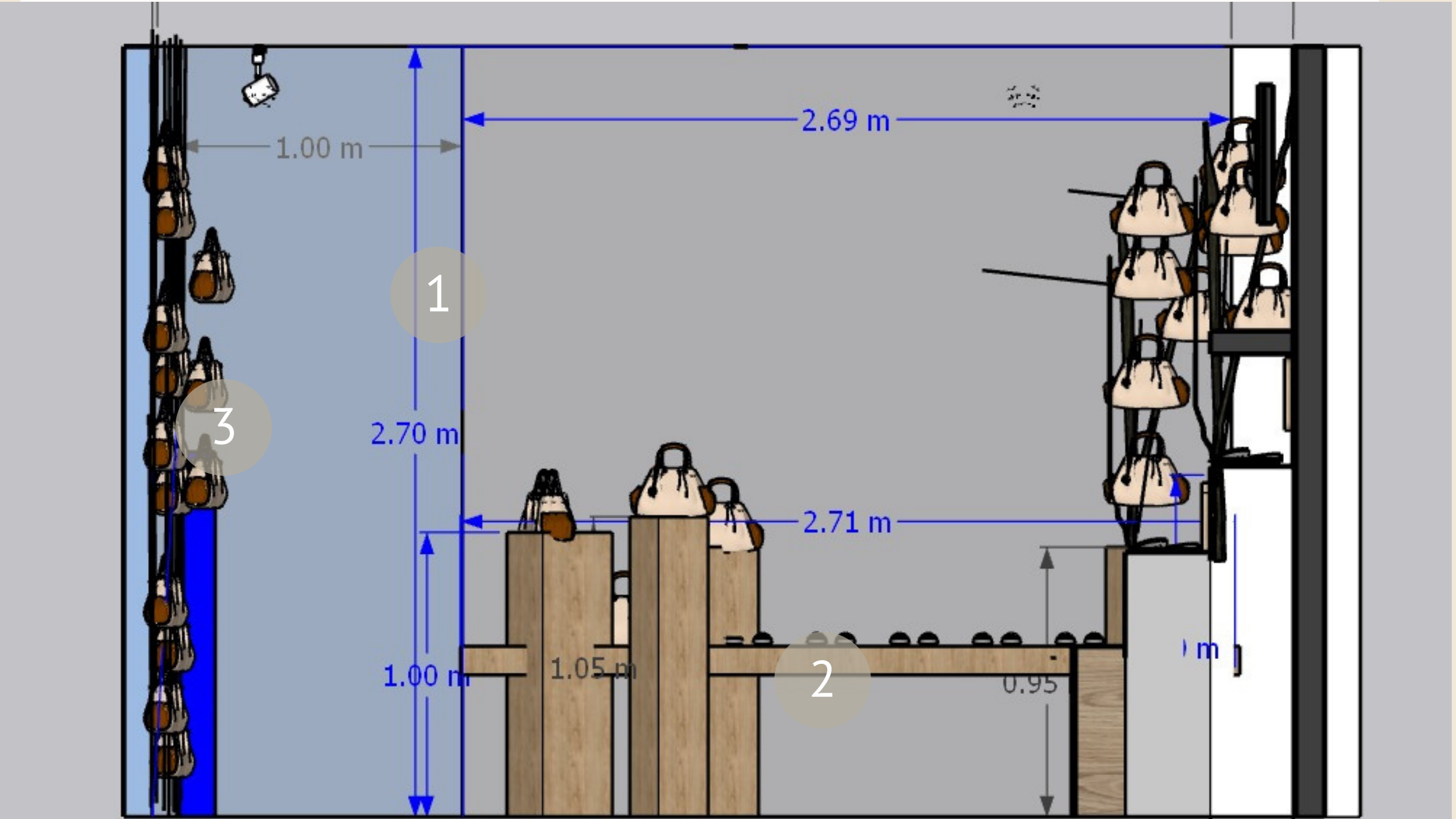

3

DETALLES

1. COUNTER

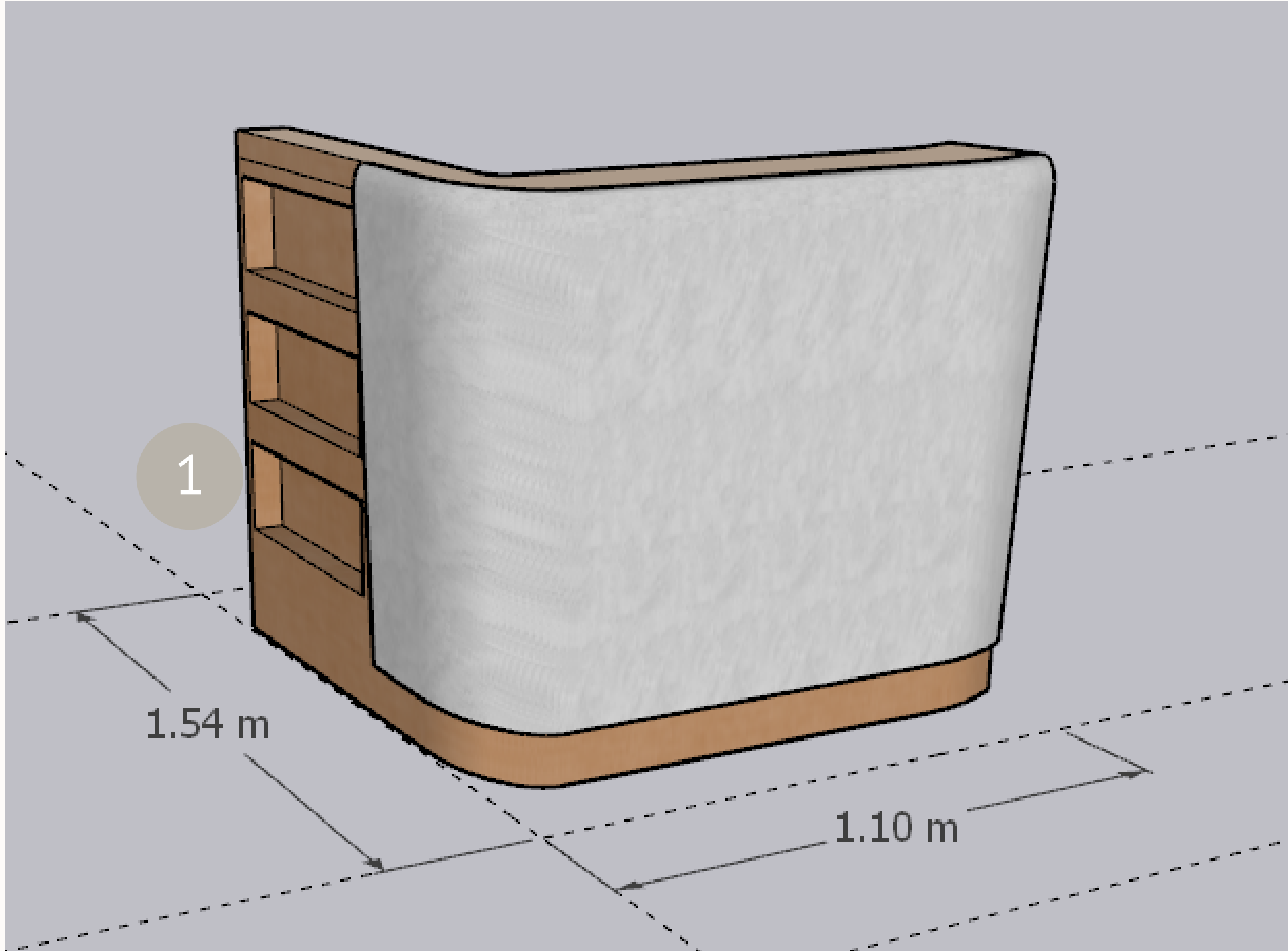

3

DETAILES

P A P E L T A P I Z
V E L V E T



4

C O M P R A S

PAPEL TAPIZ
VELVET

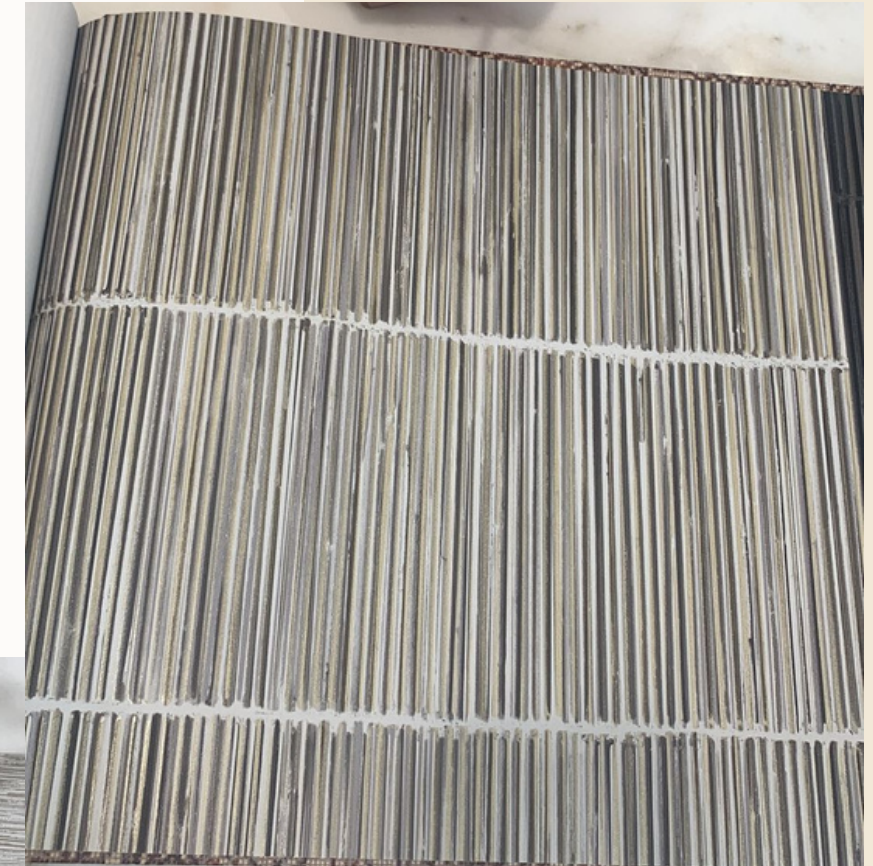

4

COMPRAS

LUMINATTI

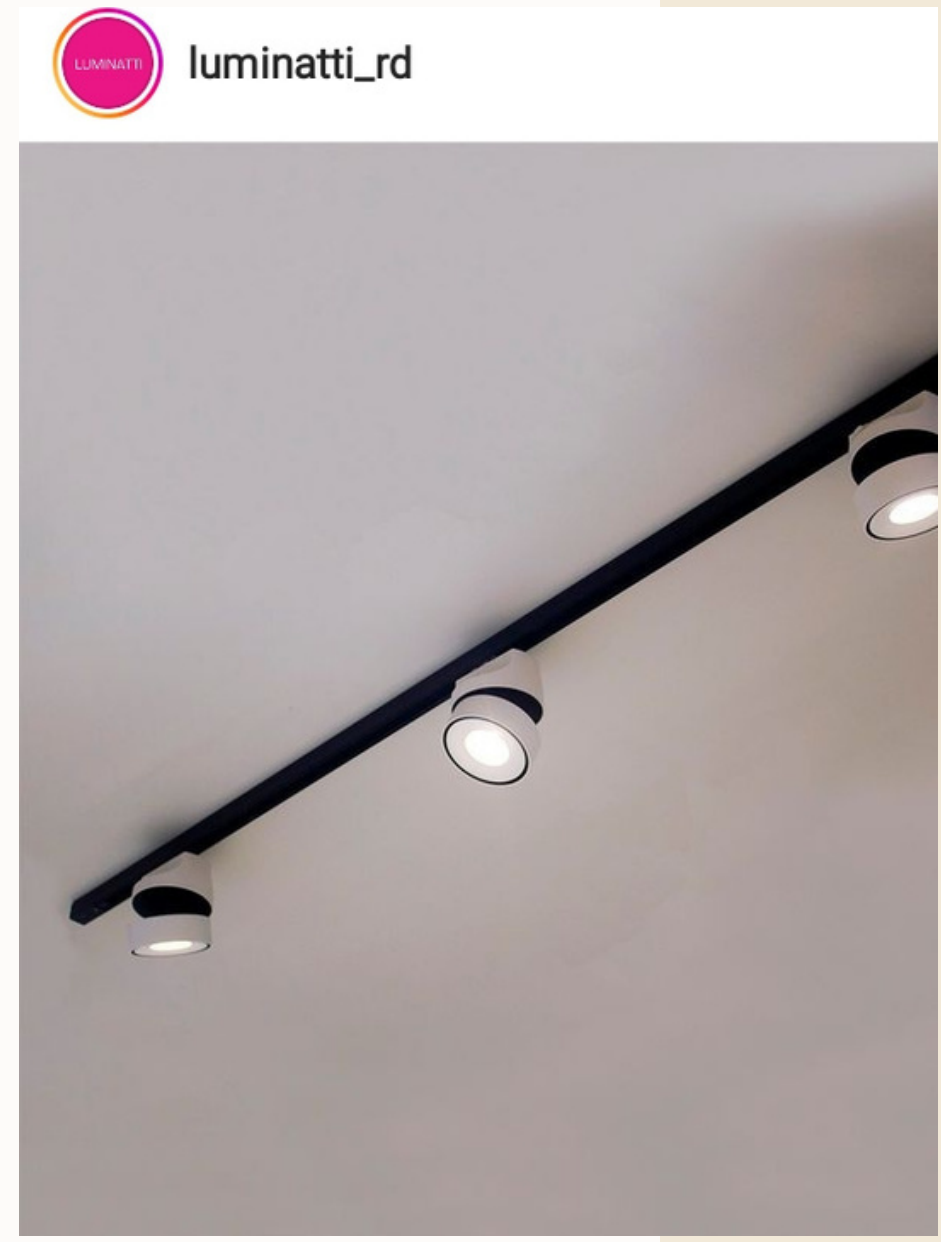

4

COMPRAS

RESULTADOS



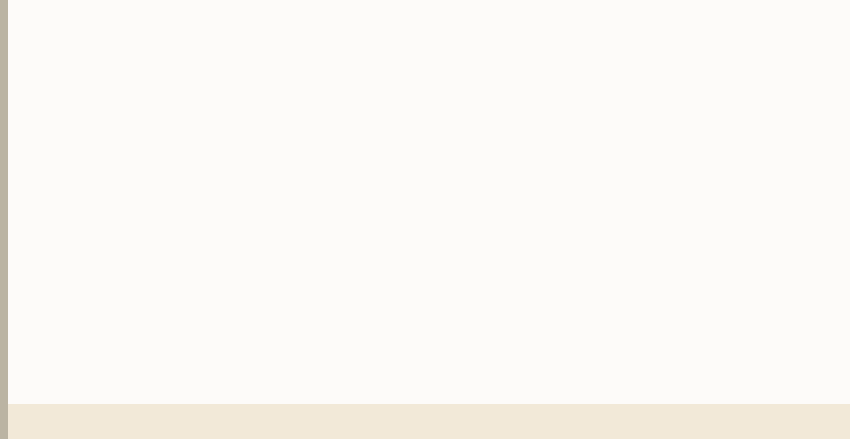
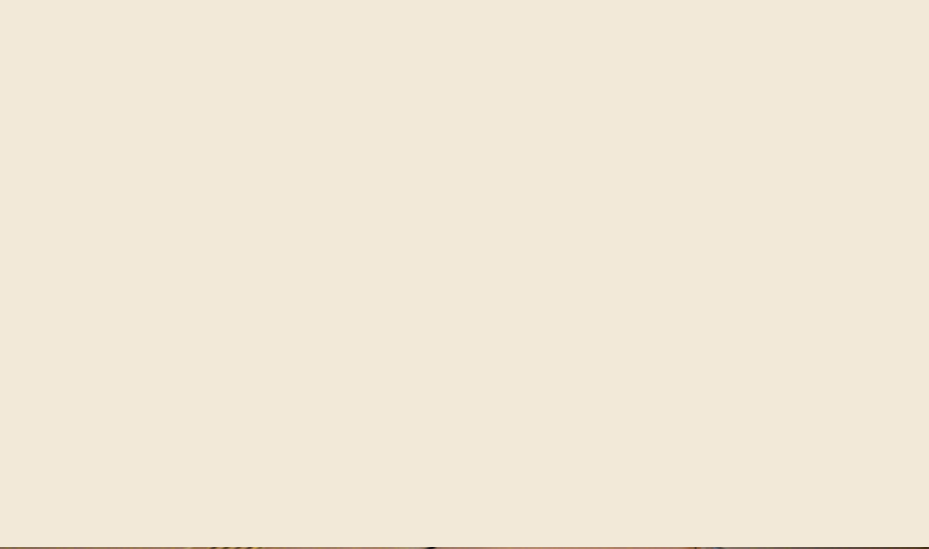





MUCHAS GRACIAS

NUESTRO EQUIPO QUEDA AGRADECIDO POR LA CONFIANZA DEPOSITADA EN SU PROYECTO. QUEDAMOS A LA ORDEN PARA LA ETAPA DE EJECUCIÓN Y DECORACIÓN, YA SEA EL PROYECTO COMPLETO, POR FASE O SELECCIÓN DE MOBILIARIOS.

SI SOLO DESEA LA FABRICACION DE MOBILIARIOS A LA MEDIDA PUEDE CONTRATARLO A TRAVÉS DE MADERA DESIGN.

M A D E S I G N S R L